

## RFID-BASED DIGITAL BOARD GAME PLATFORMS

JungHyun HAN

*Game Research Center, College of Information Communications  
Korea University, Seoul, Korea  
e-mail: jhan@korea.ac.kr*

Kiyeol KIM

*Ui2 Corporation, Seoul, Korea*

Keechul JUNG

*School of Media, Soongsil University, Seoul, Korea*

Kyung-Ok LEE

*Child Game Research Center, Department of Early Childhood Education  
Duksung Women's University, Seoul, Korea*

Manuscript received 8 December 2008; revised 20 April 2010

Communicated by François Brémond

**Abstract.** This paper presents digital board games built upon RFID-based platforms. The platforms consist of RFID tag-embedded physical objects and RFID reader boards. A library is built upon the platforms for recognizing data, locations, and movements of the physical game objects. Three kinds of game prototypes are designed and developed for use in young children's edutainment. The user tests prove that a natural type of interactivity can be achieved for digital board games, and it can contribute to establishing paradigms for next-generation edutainment.

**Keywords:** Digital board game, RFID, object identification, motion tracking, edutainment

**Mathematics Subject Classification 2000:** 68U99

## 1 INTRODUCTION

The games used for training, advertising, simulation, or education are collectively called serious games. One of the major and traditional areas in the serious games is educational entertainment, or *edutainment* in short, that seeks to educate the audience by embedding lessons in a familiar form of entertainment.

In edutainment, a computer has played a key role. However, its input devices such as mouse and keyboard provide abstract and symbolic interfaces. These interfaces are often found to be inappropriate for developing edutainment content targeted at young children. According to Piaget [1], young children build their own intellectual structure and knowledge by actively exploring the real world. Natural interfaces using real-world objects stimulate young children to independently expand their intellectual structures. Edutainment content, with such natural interfaces, enhances both the fun of playing and educational effectiveness.

Radio frequency identification (RFID) is an automatic identification method, which stores and remotely retrieves data using RF signals. The RFID technology is useful for coupling the physical world to the virtual world, and has recently attracted great attention for implementing a context-aware computing environment, which should have the capability of recognizing and reacting to real-world contexts.

In this paper, we first present the RFID-based digital board game platforms. The hardware components comprise RFID tag-embedded physical objects and RFID reader boards. Two types of the board are presented: one is a single RFID reader, and the other contains an array of RFID antennas. Then, we show that a library of utility functions can be built upon the platforms for recognizing data, locations, and movements of the physical game objects. Three kinds of game prototypes designed for use in young children's edutainment are presented, and then the user test results are discussed. We conclude that the natural interactivity brought by the RFID technologies can contribute to establishing paradigms of the next-generation edutainment for young children.

## 2 RELATED WORK

Augmenting an off-line game with information-technological functionality has been explored under the name of a ubiquitous computing game. Pioneering prototypes of ubiquitous computing games have been reported by the academic community. In Smart Playing Cards [2], a classical card game is extended by attaching RFID tags

to the cards. It allows monitoring of the game play, keeping track of the players' scores, and providing playing hints for game players.

Smart Jigsaw Puzzle Assistant [3] is also an augmented real-world game, where RFID tags are embedded in all of the jigsaw pieces. In the game, the user can move a palm-sized RFID reader over the jigsaw pieces until it detects a piece that can be matched to the already combined pieces of the puzzle. Alternatively, the user can pick up a random jigsaw piece; then its position in the puzzle board is visualized on computer screen.

In the commercial field, a few RFID-based games can be found. An example is Mattel's HyperScan game system [4]. It uses both CD-ROM and RFID, making it a hybrid machine for both video games and collectible card games. Players scan cards and enhance their abilities of the in-game characters.

The above examples proved the potential of RFID technologies in coupling physical game objects with the virtual world. However, RFID technologies are tightly coupled with specific games, and simply augment the features of those games. In contrast, this paper presents *general* RFID-based platforms, where a wide variety of board games can be built. The generality is achieved by building a library of utility functions on top of the platforms, and the library presented in this paper is used for recognizing data, locations, and movements of the physical game objects.

A tabletop computer provides natural interfaces through gestures, touch or physical objects, and can work as a general game platform. A main functionality of the table-top computer is object recognition. For example, in Microsoft Surface [5], the cameras in the machine's housing can recognize objects placed on the surface if those objects have identification tags similar to bar codes. In the tabletop computing environment, the digital games can be augmented with physical objects, such as pawns and bats, for improving user experience in playing games. For a seminal work of the tabletop games in laboratory research settings, readers are referred to [6].

Note that the ingredients of the game platforms presented in this paper are distinct from those of the tabletop computer: Our platforms are based solely on RFID technologies, and can be easily fabricated from off-the-shelf components.

### 3 ARCHITECTURE OF THE GAME PLATFORM

As shown in Figure 1, the digital board game platform consists of 1) the tangible objects with RFID tags embedded, 2) the RFID-reading game board, and 3) a PC connected to the game board. The tangible objects and game board work as input devices. Neither keyboard nor mouse is used.

An RFID tag is embedded into a physical object such that each object can obtain its own unique ID. Figure 2 a) shows various instances of sticker-type RFID tags. The sticker-type RFID tags easily stick to real-life objects. Figure 2 b) shows a game object with an RFID tag embedded in it.



Fig. 1. Components of the digital board game platform

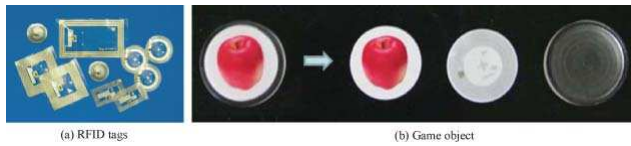

Fig. 2. RFID tags and game object

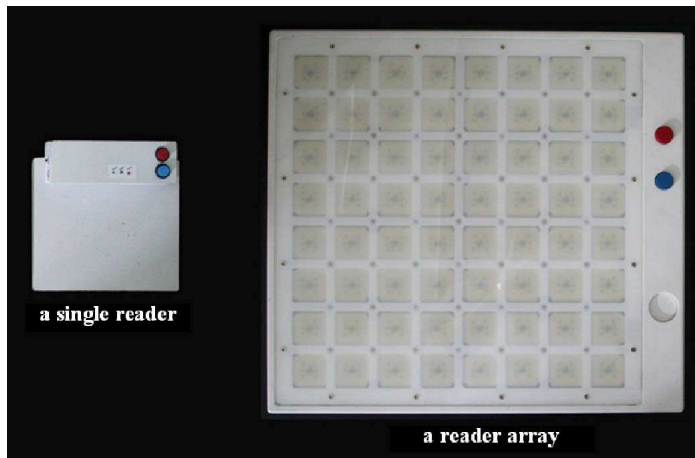

Fig. 3. Game boards

As shown in Figure 3, we have designed two types of game board. The simpler one contains a single RFID reader with an antenna. Note that an RFID reader with an antenna can identify multiple objects at the same time, but cannot distinguish among their positions.

To support the games which need to distinguish among the positions of multiple game objects or further to track an object's motion, an RFID-reader array has been designed. It is equipped with 8 RFID readers, each having 8 antennas. The  $8 \times 8$  array of the antennas is disposed in a square area, as shown in Figure 3. In the reader array, 3 LEDs (red, yellow, and blue), used for special effects, are attached to an antenna. Note that the reader array is so general that any game running on the single reader can be ported to the reader array.

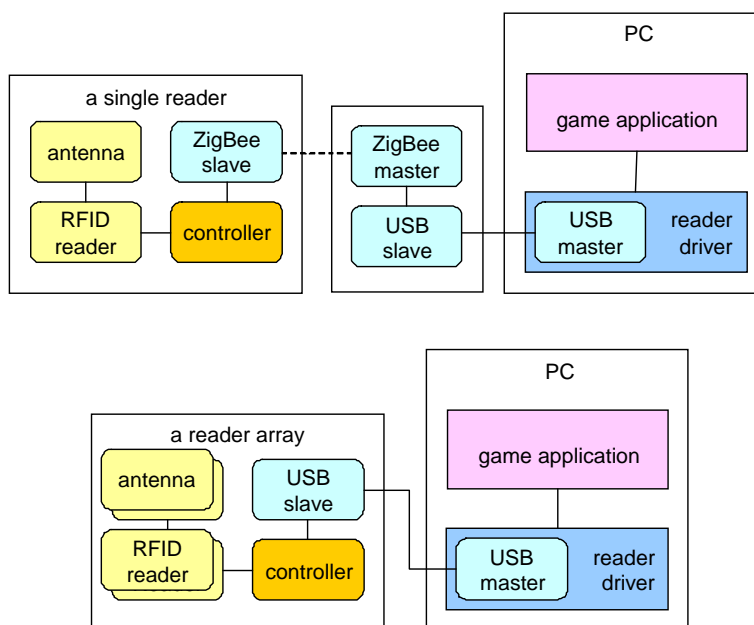

Fig. 4. Architectures of game boards with PCs

The PC connected to the RFID reader board runs the reader driver and the game applications. As shown in Figure 4, the single reader board is so light and mobile that it is connected to the PC using ZigBee<sup>1</sup> protocols whereas the reader array board is connected to the PC through a USB connection.

The RFID tags are embedded in the game objects, and the RFID readers are hidden underneath the game board surface. They are all invisible. A game built on this platform may look like a traditional board game, as will be shown in the next

<sup>1</sup> ZigBee is a protocol based on IEEE 802.15.4-2003 standard for wireless personal area networks.

sections, and therefore fulfils the goal of providing natural and tangible interfaces to young children.

## 4 OBJECT IDENTIFICATION

Two main functionalities of the digital board game platform presented in this paper are *object identification* and *motion tracking*, and are discussed in this and the next sections, respectively. This section presents two board game prototypes. One is built upon the single reader board, and demonstrates the capability of simultaneously identifying multiple objects. The other is built upon the reader array board, and demonstrates the capability of extending the functions of a traditional board game to maximize the interactivity between the game and the user.

### 4.1 A Single Reader-Based Game



Fig. 5. A single reader-based board game, Fruit Market

As a prototype game on the single reader board, we have designed and developed a *pretend play game*, which we name Fruit Market. The game snapshots in Figure 5 show how the game proceeds. As shown in the first two pictures, the user is asked to place fruits to buy on the board, and the user places two apples, a banana, and a grape. Then, as shown in the last picture, the game program computes the total cost, 17 peas, and finally judges if the requested peas are correctly placed on the board. Note that, in Fruit Market built upon the RFID-based platform, neither keyboard nor mouse is used for game play.

As demonstrated in Figure 5, multiple game objects can be simultaneously identified, i.e. multiple RFID tags can be read at the same time. This is not the case in bar code reading. Even though the bar code technology and RFID share a few common features such as *contactless reading*<sup>2</sup>, they also show significant differences. Unlike the bar code, the data stored in the RFID tag are invisible, and the RFID tag is writable. The amount of data stored in an RFID tag can be much larger than

<sup>2</sup> The techniques for recognizing data attached or embedded in an object include magnetic code, IC (integrated circuit) card, bar code, and RFID. Unlike the bar code and RFID, the magnetic code and IC card work in a *contact mode*.

that of a bar code. Above all, multiple RFID tags can be read simultaneously. In designing a digital board game, such features of RFID bring more flexibility than the bar code technology.

The pretend play game, Fruit Market, is targeted towards 3 to 4 years old children. After the age of 2, children start to develop their imagination and cognitional representation system. Pretend play is a representative phase of such cognitive development of young children, and therefore pretend play game is an excellent activity for 3 to 4 years old children [7].

As discussed earlier, the sticker-type RFID tag easily sticks to a real-life object that can then replace the game object. Pretend play with real-life objects brings daily life experiences of young children to the game context, enables young children to act out everyday activities, and promotes high level of concentration [1].

## 4.2 A Reader Array-Based Game

Figure 6 shows snapshots of a game based on the RFID-reader array board, which we name Make a Path. A pad is overlaid on the surface of the reader board to specify the start and goal positions<sup>3</sup>. When the game starts, the obstacle cells are randomly generated and colored in red on the board. The user's mission is then to place appropriate blocks onto the cells of the pad and connect the start and goal positions without colliding into obstacles.

Drawn on the top face of each block is a pipe, which is either straight or bent. In Figure 6 a), the path in construction is shown as connected pipes on the game board. (The path is also displayed on the PC screen, but the display is not an essential part of the game.)

Note that, as shown in Figure 6 a), the 6<sup>th</sup> block should be a bent pipe, not a straight one, for avoiding the obstacle. Suppose, however, that a straight pipe is placed at the position, as shown in Figure 6 b). Then, the game, running on the PC, notifies the user of such a misplaced block, as shown in Figure 6 c), where all of the red LEDs are turned on, so that the player can replace the block by a correct one. Figure 6 d) shows a completed path.

Make a Path is the digitalized version of a traditional board game. Such a digitalization enables *interaction* between the board game and the user. Figure 6 shows just an example of interactivity brought by the RFID-based platform. Even though the start and goal positions are successfully connected without colliding into obstacles, the path may not be optimal in the sense that it is not the shortest. Then, the game running on the PC asks the user for another trial, either in the middle of or after completion of pipe connection. In contrast, the game rule could be changed such that the optimal path is the longest path. All that needs to be done for supporting such interactivities is to change the game functions in the PC program.

---

<sup>3</sup> The pad has  $7 \times 7$  cells even though the RFID antennas are configured in an  $8 \times 8$  array, i.e. the pad covers a  $7 \times 7$  sub-array of the RFID antennas. The remaining 15 cells of the board are saved for other purposes such as displaying a progress bar.

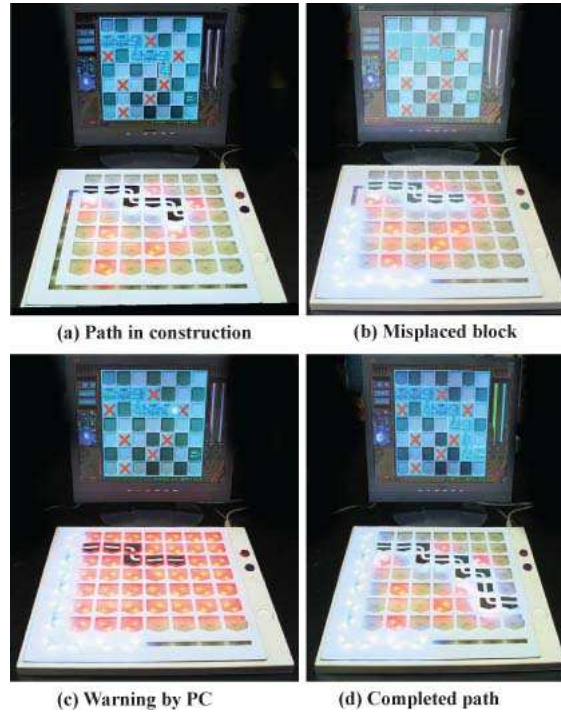

Fig. 6. A reader array-based board game, Make a Path

The interactivity enabled by the RFID-based board helps young children draw *mental map*. Make a Path is suitable for children at the age of 5 or more to develop spatial ability including spatial perception, spatial orientation, eye-motor coordination and visual discrimination [8].

Finally, note that the constructed paths can be saved and retrieved on demand. Furthermore, the game can be networked such that, for example, two remote users are assigned their own start and goal positions, place a block at a time in turn, and compete with each other in connecting the shortest paths.

## 5 MOTION TRACKING AND INTERPRETATION

An array of multiple RFID readers or antennas can track the motion of an RFID tag whereas a single RFID reader with an antenna can not. Such a tracked motion can then be interpreted into a higher-level symbol. A variety of interactive edutainment games can be developed using the motion tracking capability of the reader array.



### 5.1 Motion Tracking

Figure 7 shows snapshots of a *figure recognition game*, which we name Draw a Figure. The game shows a figure to the user, as shown in the lower right corner of the screen, and then asks the user to draw its shape using an RFID tag-attached object. The  $8 \times 8$  array of antennas tracks the user's motion, and passes the tracking result to the game application in the PC, which then interprets the shape as a figure and judges if it can be matched with the given figure.

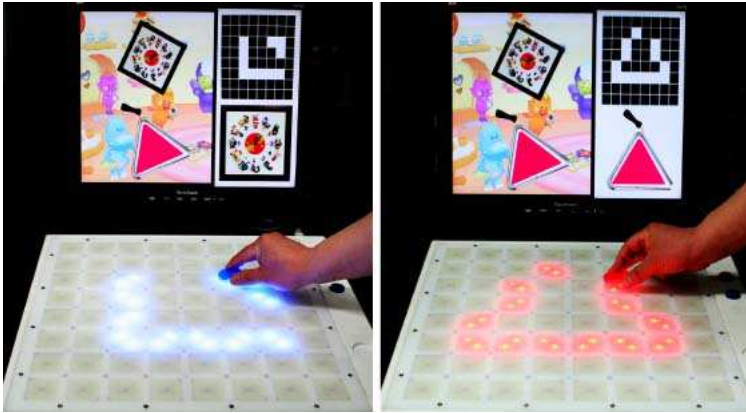

Fig. 7. A reader array-based board game, Draw a Figure

Draw a Figure is targeted towards 3 to 4 years old children. At age of 3, children start to learn the names of figures [9]. Figure drawing is a good way to practice figure recognition and to understand the diversity of figures using sensory-motor experience.

stages	action time	cumulative time	remarks
RFID reading	3	24	8 antennas
antenna switch	10	70	7 switches needed
board-to-PC	10	10	
total		104	

Table 1. Sampling time analysis (in ms)

The motion of an RFID tag-attached object can be tracked by periodically sampling its position. Table 1 analyzes the sampling time of the reader array. It takes 3 ms for an antenna to identify an RFID tag. Recall that, in the reader array, an RFID reader has 8 antennas. For a reader, only a single antenna can be activated at a time. It takes 10 ms to switch between antennas, i.e. to deactivate an antenna and then to activate the next one. In total, an RFID reader requires 94 ms ( $= 8 \times 3 + 7 \times 10$ ) to have all of its antennas read the RFID tag. All of

the RFID readers work concurrently, and therefore the reader array board spends 94 ms on detecting the RFID tag position. In addition, it takes 10 ms to transfer the detected position to the PC. As shown in Table 1, the object position is sampled in 104 ms, i.e. the sampling rate is about 10 Hz, which is enough to track the motion of 3 or 4 years old children.

Figure 8 shows some examples of the input sequence of the cells produced by motion tracking. The first sampled position is denoted by 1. (Shown below each example is the chain code, which will be discussed shortly.) When the drawing motion is fast, the boundary of a figure may have missing cells, as shown in many examples of Figure 8. In the worst-case example of the current experiments, about 50% of the cells are missing. Consider the  $5 \times 5$ -sized rectangle in Figure 8 a). Its boundary is composed of 16 cells, but only 8 cells are detected.

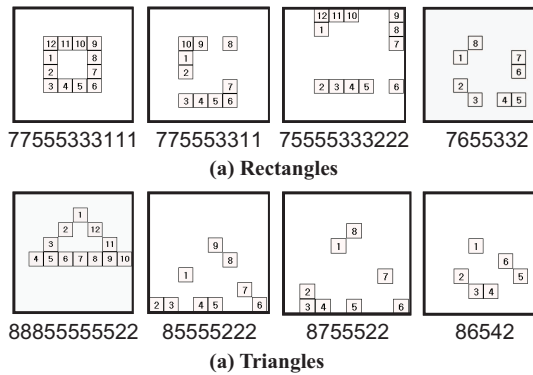

Fig. 8. Input sequence and chain code

## 5.2 Figure Matching

The input sequence is interpreted into a figure, either a rectangle or a triangle in the current implementation. For real-time interpretation, K-NN (nearest neighbor) classification algorithm [10] is adopted, which is well-known for its real-time performance, especially for a small number of classes. For a digital board game, such as Draw a Figure, targeted at young children's edutainment, the number of classes is usually restricted to be small, e.g. 10 figure classes. Therefore, the K-NN algorithm is a good choice.

As a representation of the input and reference feature vectors for the K-NN algorithm, we use a chain code [11]. In the chain code, the user's motions are recorded in direction symbols quantized into eight digits, 1 through 8, as shown in Figure 9. Consider the first example of Figure 8 a). The move from the 1<sup>st</sup> cell to the 2<sup>nd</sup> is characterized by direction 7; therefore, the chain code starts from 7.

For measuring the distance between the input and reference feature vectors, we use a DTW (dynamic time warping) [11] technique, which can make the system

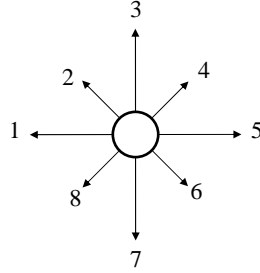

Fig. 9. Direction symbols in a chain code

scale invariant. Suppose that the chain codes for the input and reference feature vectors are  $A = \{a_1, a_2, \dots, a_I\}$  and  $B = \{b_1, b_2, \dots, b_J\}$ , respectively. The elements  $\gamma(i, j)$  of the  $I \times J$  matrix are defined as follows:

1.  $\gamma(1, 1) = d(a_1, b_1)$
2. First row:  $\gamma(l, j) = \gamma(l, j - 1) + d(a_l, b_j)$ , for  $2 \leq j \leq J$
3. First column:  $\gamma(i, l) = \gamma(i - l, l) + d(a_i, b_l)$ , for  $2 \leq i \leq I$
4. All other elements:

$$\gamma(i, j) = \min \left\{ \begin{array}{l} \gamma(i, j - 1) + d(a_i, b_j), \\ \gamma(i - 1, j - 1) + 2 \times d(a_i, b_j), \\ \gamma(i - 1, j) + d(a_i, b_j) \end{array} \right\} \quad (1)$$

where  $d(a_i, b_j)$  is the distance between the directional codes,  $a_i$  and  $b_j$ :

$$d(a_i, b_j) = \left\{ \begin{array}{ll} |a_i - b_j|, & \text{if } |a_i - b_j| < 5 \\ 8 - |a_i - b_j|, & \text{otherwise} \end{array} \right\}. \quad (2)$$

In order to compute the final distance between the feature vectors  $A$  and  $B$ , the different lengths of  $A$  and  $B$  are resolved through normalization:

$$D(A, B) = \frac{\gamma(I, J)}{I + J} \quad (3)$$

In the experiments, we have chosen two classes: square and triangle. The figure matching algorithm's performance is evaluated using a figure database containing 120 samples per class. For K-NN training, a set of 20 samples, randomly chosen from the database, is used. Then, the matching program is run for the remaining 100 samples. For a figure class, we run four experiments, each with a different training

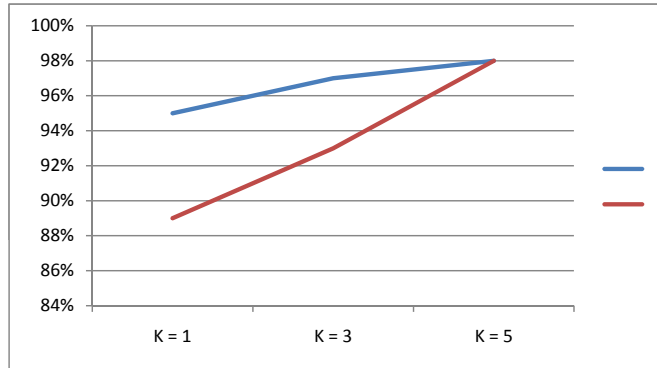

Fig. 10. Performance graphs in terms of recognition rates

set. Four different experiments show very similar recognition rates, and Figure 10 shows the average recognition rate.

As shown in Figure 10, the performance of the K-NN algorithm depends on parameter K, the number of the reference vectors closest to the input vector. In the experiments with K = 1, 3, 5, we can achieve an almost perfect recognition rate, 98 % for both rectangles and triangles when K is 5.

## 6 IMPLEMENTATIONS

In the current implementation, the RFID tags are fabricated using Texas Instruments Tag-it™ HF-I plus transponder inlays, consisting of 13.56 MHz transponders that are compliant with ISO/IEC 15693 and ISO/IEC 18000-3. These products offer a user-accessible memory of 2048 bits, organized in 64 blocks. The RFID reader is fabricated using Texas Instruments S6700 Multi Protocol Transceiver IC, which supports 13.56 MHz RFID interrogation.

## 7 DISCUSSION

### 7.1 Motion Tracking Performance

Recall that it takes 10 ms to switch between antennas whereas it takes 3 ms for an antenna to identify an RFID tag. Antenna switching is the major bottleneck in motion tracking.

As discussed in Section 5.1, the object position is sampled at about 10 Hz, and it is enough to track the motion of 3 or 4 year old children. If a higher sampling rate is required for new applications, however, we could reduce the number of antennas connected to an RFID reader and install more readers into the reader board. For example, we could attach 4 antennas to an RFID reader and install 16 readers

stages	action time	cumulative time	remarks
RFID reading	3	12	4 antennas
antenna switch	10	30	3 switches needed
board-to-PC	10	10	
total		52	

Table 2. Sampling time analysis for an improved board (in ms)

into the reader array board to maintain the same number of total antennas. Then, an RFID reader requires 42 ms ( $= 4 \times 3 + 3 \times 10$ ) to activate all of its 4 antennas. The new version of the reader array would work in about 25 Hz, as shown in Table 2.

Note that the finer resolution of the reader board enables the finer control over the games, and consequently the wider spectrum of games can be developed. A finer resolution board of  $16 \times 16$  RFID antennas is currently being designed.

## 7.2 Teacher's Evaluation

The game Fruit Market built upon the single RFID reader board was evaluated by surveying 29 teachers in child care centers, enrolled in the masters program of Early Childhood Education in Duksung Women's University and Kyungin Teacher's College, Korea. The original game was compared with its slight modification which takes the user input from the keyboard, not from the reader board. In the keyboard version of Fruit Market, the fruit- and pea-stickers are attached to specific keys, in order to provide an intuitive interface for the 3 to 4 years old children who are the target users of the game.

Out of the software evaluation instrument in [12], fourteen items (questions) most relevant to Fruit Market were selected. The questionnaire is organized in five categories shown in Table 3. Each item was evaluated by 5-point Likert scale, and analyzed with the paired t-test to measure the score difference between the RFID reader version and the keyboard version.

In the category 'Design Features', the paired t-test results indicated that, at  $\alpha = 0.05$ , the scores of RFID reader version were significantly higher than those of the keyboard version on both of the items, D1 ( $t(28) = -2.294$ ) and D2 ( $t(28) = -2.302$ ). The results imply that designs of the customized feedback and item construction in the RFID version were highly esteemed.

In the category 'Entertaining Value', the scores of RFID reader version were also higher than those of the keyboard version on all of three items, T1, T2, and T3. Note that items T1 ( $t(28) = -2.386$ ) and T2 ( $t(28) = -2.576$ ) were significantly high at  $\alpha = 0.05$ , but T3 ( $t(28) = -1.307$ ) was not statistically significant. Teachers took the RFID game program and its graphics/sound components as more enjoyable, but the responsiveness to a child's actions was of little difference between the keyboard and RFID reader versions.

In the category 'Educational Value', the scores of RFID reader version were higher than those of the keyboard version on all of three items E1, E2, and E3.

Note that item E3 ( $t(28) = -2.121$ ) was significantly high at  $\alpha = 0.05$ , but E1 and E2 were not statistically significant. Teachers highly appreciated the RFID version's feedback functionality, but the graphics/sound aspects of the feedback and the game presentation were not highly appreciated. It might be because the games were just prototypes, not commercially complete products.

On two items U1 and U3 in the category 'Ease of Use', the scores of RFID reader version were higher than those of the keyboard version at  $\alpha = 0.05$ , where U3 ( $t(28) = -2.049$ ) was significantly high and U1 was not statistically significant. In contrast, the score of the keyboard version was higher than that of the RFID reader version on item U2, but it was not statistically significant at  $\alpha = 0.05$ . The results show that teachers believed that children could easily get in or out of the game activities but there was little difference between the keyboard and RFID reader versions both in independently playing the game and in the degree of difficulty for game operation. The teacher evaluation was conducted after a short introduction to the game programs, and the teachers might have difficulties in fully understanding the game operation rules or they might have some anxiety about using new technologies. Teachers' anxiety about using computers was reported in [13].

It can be concluded that the RFID reader version provides good design features, entertaining and educational values, and ease to use. For category 'Childproof', however, it is not possible to draw a similar conclusion. On item C1 ( $t(28) = -3.198$ ), the score of RFID reader version was higher than that of the keyboard version even at  $\alpha = 0.01$ . On item C3, the score of RFID reader version was higher but it was not statistically significant at  $\alpha = 0.05$ . In contrast, on item C2, teachers answered the keyboard version would operate more smoothly than the RFID reader version ( $t(28) = 2.174, p < 0.05$ ). The reason why teachers gave a high credit to the keyboard version would be that they were generally familiar with the keyboard operations. In general, adult users are known to be more conservative in adapting to new media and technologies than young children [14].

For the RFID reader-array board games, teacher survey was not conducted because each of the games, Make a Path and Draw a Figure, is a proof-of-concept implementation and cannot be taken as concrete content for young children (unlike Fruit Market). Young children have difficulties in playing abstract tasks. However, teachers' comments were gathered after game-play demonstrations. The general opinions were as follows: the array board games would give a better way for young children to interact/communicate with the content than the traditional interface-based games because the array board games can give direct feedback from the board panel using the LEDs, and can often work without screen. Further user studies are to be performed with concrete content built upon the RFID-reader array.

## 8 CONCLUSION

This paper presents two types of RFID-based digital board game platforms: One uses a single RFID reader, and the other uses an array of RFID antennas. Then,

$M(SD)$ ,  $N = 29$ 

Categories	Items	Keyboard	RFID reader	t-value	p
Design Features (How <i>smart</i> is this program?)	D1.Feedback is customized in some way to an individual child.	3.67 (0.832)	4.04 (0.706)	-2.294*	0.030
	D2.Item construction is appropriate for children.	3.78 (0.641)	4.07 (0.730)	-2.302*	0.030
Entertaining Value (Is this program fun to use?)	T1.The program is enjoyable to use.	3.66 (0.897)	4.14 (0.953)	2.386*	0.024
	T2.Graphics and sound are enjoyed by children.	3.62 (0.862)	3.97 (0.731)	-2.576*	0.016
	T3. The program is responsive to a child's actions.	3.96 (0.793)	4.14 (0.848)	-1.307	0.202
Educational Value (What can a child learn from this program?)	E1.Offers a good presentation of one or more content areas.	3.79 (0.686)	4.07 (0.716)	-1.686	0.103
	E2.Feedback employs meaningful graphic and sound capabilities.	3.83 (0.759)	3.97 (0.865)	-0.724	0.475
	E3.Feedback reinforces content (embedded reinforcements are used).	3.75 (0.645)	4.04 (0.693)	-2.121*	0.043
Ease of Use (Can a child use it with minimal help?)	U1.Children can use the program independently after the first use.	4.00 (0.707)	4.10 (0.772)	-0.682	0.501
	U2.Skills needed to operate the program are in the range of a child.	3.76 (0.435)	3.72 (0.797)	0.205	0.839
	U3.It is easy to get in or out of any activity at any point.	3.86 (0.651)	4.11 (0.629)	-2.049*	0.050
Childproof (Is it designed with <i>child-reality</i> in mind?)	C1.It is developmentally appropriate for children to control.	3.62 (0.903)	4.14 (0.693)	-3.198**	0.003
	C2.This program would operate smoothly.	4.11 (0.416)	3.71 (0.897)	2.174*	0.039
	C3.It is easy for a child to control.	3.83 (0.658)	4.07 (0.704)	-1.565	0.129

\*  $p < 0.05$ , \*\*  $p < 0.01$ 

Table 3. Evaluation and analysis of Fruit Market

we show that a library of utility functions can be built upon the platforms for recognizing data, locations, and movements of the physical game objects. Three kinds of game prototypes designed for use in young children's edutainment are presented. Each game takes tangible objects as input devices, and uses the library for providing a natural interface for the user. The evaluation results prove that the RFID-based digital board games can be effectively used for the young children's edutainment purpose.

A wide spectrum of edutainment or serious games can be built on the platform. To support developing such games, however, more effort needs to be made to provide various utilities and libraries for game developers. The utilities should be portable to a set of distinct boards, i.e. a single reader, an  $8 \times 8$  reader array, and a  $16 \times 16$  reader array, which is currently being designed. The system is being extended along these directions.

### **Acknowledgement**

This research was supported by Korea Game Industry Agency, Korea Ministry of Culture, Sports and Tourism.

### **REFERENCES**

- [1] PIAGET, J.: *The Science of Education and the Psychology of the Child*. Viking, New York 1971.
- [2] RÖMER, K.—DOMNITCHEVA, S.: Smart Playing Cards: A Ubiquitous Computing Game. *Journal for Personal and Ubiquitous Computing*, Vol. 6, 2002, pp. 371–378.
- [3] BOHN, J.: The Smart Jigsaw Puzzle Assistant: Using RFID Technology for Building Augmented Real-World Games. *Proc. of the Workshop on Gaming Applications in Pervasive Computing Environments (at Pervasive 2004)*, Vienna, Austria 2004.
- [4] HyperScan, <http://www.toywiz.com/hyperscan.html>.
- [5] Surface, <http://www.microsoft.com/surface>.
- [6] MAGERKURTH, C.—MEMISOGLU, M.—ENGELKE, T.—STREITZ, N.: Towards the Next Generation of Tabletop Gaming Experiences. *Proc. of Graphics Interface*, pp. 73–80, London (Ontario, Canada) 2004.
- [7] BERK, L.: *Child Development*. Pearson Education, Inc., Boston, USA 2006.
- [8] GRANDE, J.: Spatial Sense. *Arithmetic Teacher*, Vol. 73, 1990, No. 6, pp. 4–20.
- [9] NAEYC & NCTM, *Early Childhood Mathematics Education: Promoting Good Beginnings*. <http://www.naeyc.org/about/positions/psmath.asp>, April 2002.
- [10] DUDA, R.—HART, P.—STORK, D.: *Pattern Classification*. 2<sup>nd</sup> Edition, Wiley Interscience, Hoboken (NJ, USA) 2000.
- [11] MARSHALL, S.: Review of Shape Coding Techniques. *Image and Vision Computing*, Vol. 7, 1989, No. 4, pp. 281–294.
- [12] BUCKLEITNER, W.—ORR, A.—WOLOCK, E.: *The Complete Sourcebook on Children's Software*. Active Learning Associates, Flemington (NJ, USA) 1999.



- [13] MEDVIN, M.—REED, D.—BEHR, D.: Computer Training for Preschool Teachers: Impact on Computer Self-efficacy, Values, and Anxiety. Proc. of 6<sup>th</sup> Head Start National Research Conference, Washington DC, USA, June 26–29, 2002.
- [14] PRENSKY, M.: The Role of Technology in Teaching and the Classroom. Educational Technology, Nov–Dec 2008, pp. 1–3.



**JungHyun HAN** is a Professor in the College of Information and Communications at Korea University, where he directs the Interactive 3D Media Laboratory and Game Research Center supported by the Korea Ministry of Culture, Sports, and Tourism. Prior to joining Korea University, he worked at the School of Information and Communications Engineering of Sungkyunkwan University in Korea, and at the Manufacturing Systems Integration Division of the US Department of Commerce National Institute of Standards and Technology (NIST). He received his B. Sc. degree in computer engineering at Seoul National University,

his M. Sc. degree in computer science at the University of Cincinnati and his Ph. D. degree in computer science at USC. His research interests include real-time simulation and animation for games.



**Kiyeol KIM** is the founding CEO of Ui2 Corporation, a company that develops context-aware games and solutions based on fixed and mobile RFID technologies. Prior to founding Ui2, he headed the R&D center of E-net Corporation, a company that developed e-Commerce solutions and on-line game services. He received his B. Sc. degree from the Department of Computer Science in Seoul National University.



**Keechul JUNG** is an Associate Professor in School of Media, Soongsil University, Korea. He received his Ph. D. degree in computer engineering from Kyungpook National University, Korea in 2000. He worked as a visiting researcher in the Intelligent User Interfaces group at DFKI (The German Research Center for Artificial Intelligence, GmbH), Germany, in 1999, and as a visiting researcher in the Machine Understanding Division, ElectroTechnical Laboratory in Japan, 2000. He was a postdoctoral researcher at the Institute of Information and Communication Technology, Sungkyunkwan University, Korea in 2000, and has

been a postdoctoral researcher at the PRIP laboratory, Michigan State University in 2001. His research interests include HCI, artificial intelligence, and computer vision.



**Kyung-Ok LEE** is an Associate Professor in the Department of Early Childhood Education at Duksung Women's University in Korea, and the Director of the Child Game Research Center in the same university. She received her Ph. D. degree in education psychology from the University of Southern California (USC), her Master's degree in education from the University of Cincinnati, and her Bachelors degree in textile sciences from Seoul National University. Her research interests include children's play, game and edutainment, social and emotional development, research method in early childhood education and quantitative analysis.